

TECHNICAL MANUAL / MANUAL TÉCNICO MANUEL TECHNIQUE / MANUALE TECNICO

DW-KL 50

EN

- Generators
- Combined heat and Power CHP
- Micro-cogeneration
- Smoke and gas exhaust
- Light particule movement
- Lining chutes
- Pump units
- High pressurised boilers
- Chemical extract
- Drying furnaces
- Incinerators

ES

- Grupos electrógenos
- Cogeneración
- Microcogeneración
- Extracción de humos y gases
- Movimiento de partículas ligeras
- Bajantes de lavandería
- Grupos de bombeo
- Calderas sobrepresionadas
- Extracciones químicas
- Hornos de secado
- Incineradoras

FR

- Groupes électrogènes
- Cogénération
- Micro-cogénération
- Extraction de fumées et gaz
- Mouvement de particules légères
- Descentes de blanchisseries
- Groupes de pompage
- Chaudières en surpression
- Extractions chimiques
- Fours de séchage
- Incinérateurs

IT

- Gruppi elettrogeni
- Cogenerazione
- Microcogenerazione
- Estrazione fumi da gas
- Movimento delle particelle leggere
- Unità di pompaggio
- Caldaie di potenza
- Estrazioni chimiche
- Forni di essiccazione
- Inceneritori



Length

Módulo recto

Élément droit

Elemento lineare

1000 mm

500 mm

250 mm

DWKL13

DWKL14

DWKL15

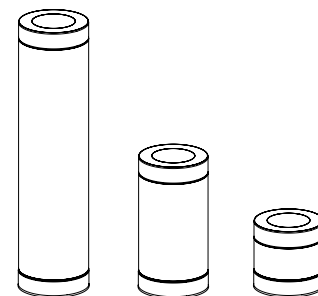
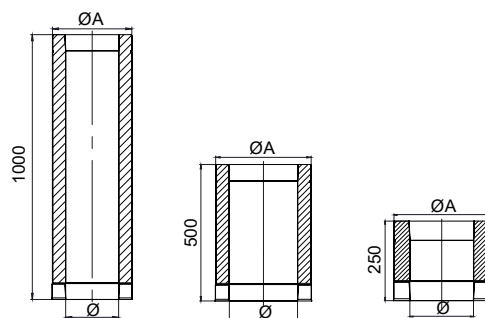

Ø	150	180	200	250	300	350	400	450	500	550	600	650	700	750	800
ØA	250	280	300	350	400	450	500	550	600	650	700	750	800	850	900

Cuttable length

Módulo recto cortable

Élément droit recoupable

Elemento lineare tagliabile

200 - 1000 mm

200 - 500 mm

DWKL13C

DWKL14C

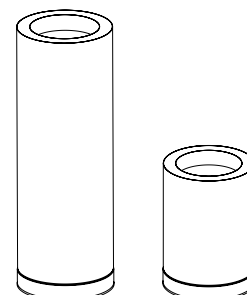
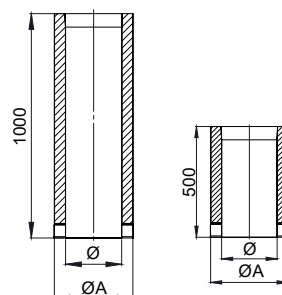

Ø	150	180	200	250	300	350	400	450	500	550	600	650	700	750	800
ØA	250	280	300	350	400	450	500	550	600	650	700	750	800	850	900

Length with lateral drain

Módulo recto con desagüe lateral

Élément droit avec purge latérale

Elemento scarico condensa laterale

250 mm

DWKL15D

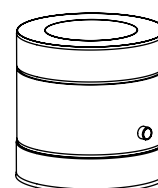
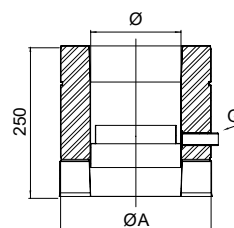

Ø	150	180	200	250	300	350	400	450	500	550	600	650	700	750	800
ØA	250	280	300	350	400	450	500	550	600	650	700	750	800	850	900
G	1/2"		1"												

Adjustable length 200 Pa (P1)

Módulo recto regulable Pa (P1)

Élément droit réglable Pa (P1)

Elemento lineare regolabile Pa (P1)

400 - 560 mm
560 - 920 mm

DWKL544

DWKL545

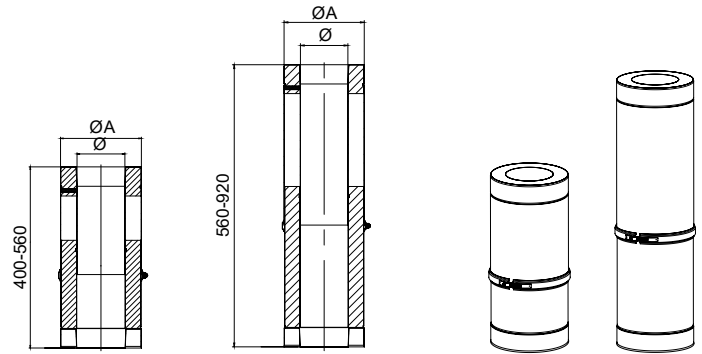

Ø	150	180	200	250	300	350	400	450	500	550	600	650	700	750	800
ØA	250	280	300	350	400	450	500	550	600	650	700	750	800	850	900

Expansion bellow

Compensador de dilatación

Longeur de dilatation

Compensatore de dilatazione

DWKL511

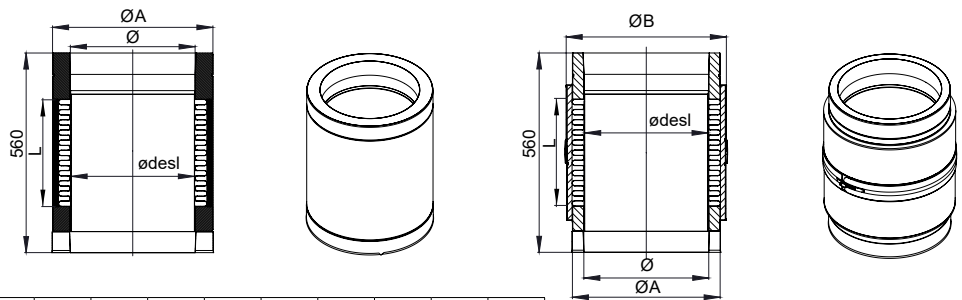

Ø	150	180	Ø	200	250	300	350	400	450	500	550	600	650	700	750	800
ØA	250	280	ØA	300	350	400	450	500	550	600	650	700	750	800	850	900
ØB	-	-	ØB	350	400	450	500	550	600	650	700	750	800	850	900	950
L	330	300	L	300	300	280	330	300	300	300	280	280	290	300	280	300

Elbow 15°

Codo 15°

Coude 15°

Curva 15°

DWKL16

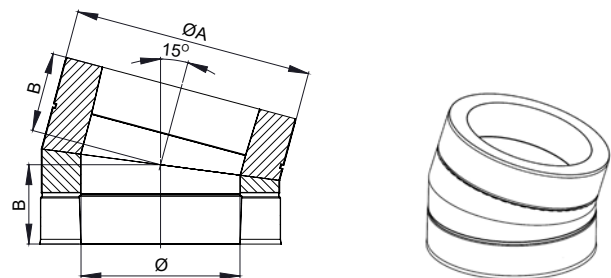

Ø	150	180	200	250	300	350	400	450	500	550	600	650	700	750	800
ØA	250	280	300	350	400	450	500	550	600	650	700	750	800	850	900
B	96	98	100	103	106	110	113	116	120	123	126	129	133	136	139

Elbow 30°

Codo 30°

Coude 30°

Curva 30°

DWKL17

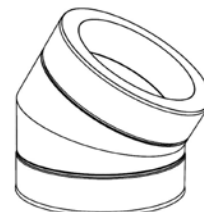
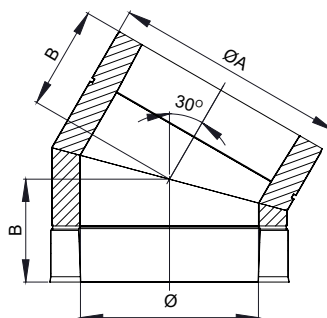

Ø	150	180	200	250	300	350	400	450	500	550	600	650	700	750	800
ØA	250	280	300	350	400	450	500	550	600	650	700	750	800	850	900
B	114	118	120	127	134	140	147	154	160	167	174	181	187	194	201

Elbow 45°

Codo 45°

Coude 45°

Curva 45°

DWKL18

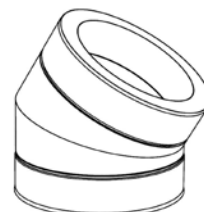
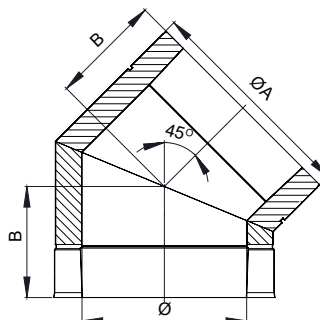

Ø	150	180	200	250	300	350	400	450	500	550	600	650	700	750	800
ØA	250	280	300	350	400	450	500	550	600	650	700	750	800	850	900
B	132	138	142	153	163	173	184	194	204	215	225	235	246	256	266

Elbow 60°

Codo 60°

Coude 60°

Curva 60°

DWKL84

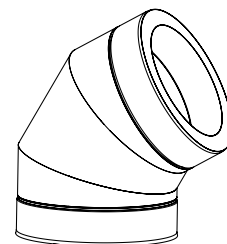
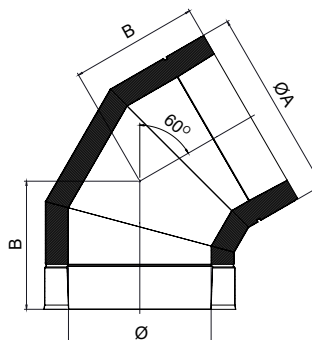

Ø	150	180	200	250	300	350
ØA	250	280	300	350	400	450
B	175	184	188	204	219	233

Elbow 87°

Codo 87°

Coude 87°

Curva 87°

DWKL64

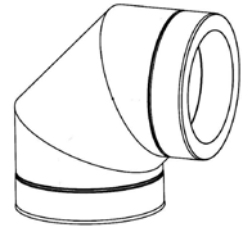
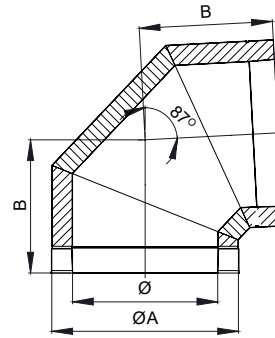

Ø	150	180	200	250	300	350
ØA	250	280	300	350	400	450
B	226	240	250	274	297	321

Elbow 90°

Codo 90°

Coude 90°

Curva 90°

DWKL60

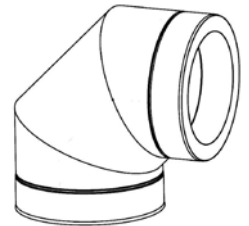
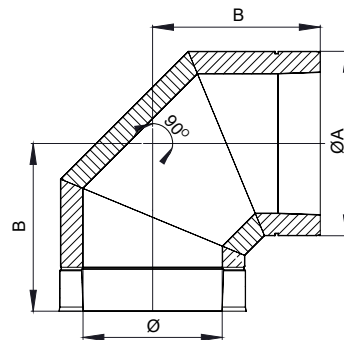

Ø	150	180	200	250	300	350
ØA	250	280	300	350	400	450
B	233	248	258	283	308	333

Tee 87°

Te 87°

Té 87°

Raccordo a T 87°

DWKL11

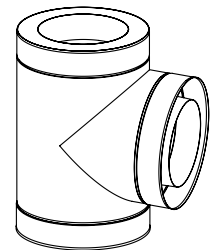
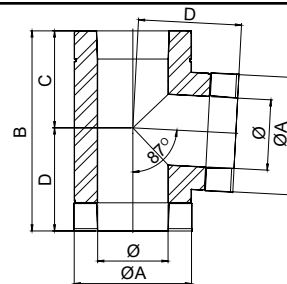

Ø	150	180	200	250	300	350	400	450	500	550	600	650	700	750	800
ØA	250	280	300	350	400	450	500	550	600	650	700	750	800	850	900
B	426	456	476	526	576	627	677	727	777	827	877	927	977	1027	1077
C	206	220	230	254	277	302	326	349	373	397	420	444	467	491	515
D	220	236	246	272	299	325	351	378	404	430	457	483	510	536	562

Tee 90°

Te 90°

Té 90°

Raccordo a T 90°

DWKL317

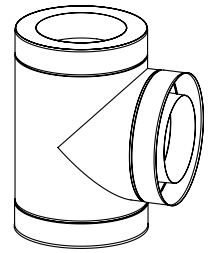
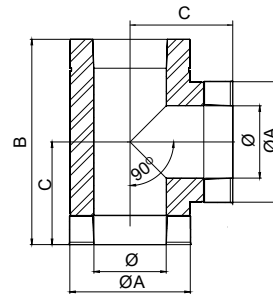

Ø	150	180	200	250	300	350	400	450	500	550	600	650	700	750	800
ØA	250	280	300	350	400	450	500	550	600	650	700	750	800	850	900
B	426	456	476	526	576	626	676	726	776	826	876	926	976	1026	1076
C	213	203	238	263	288	313	338	363	388	413	438	463	488	513	538

Tee 90° with deflector

Te 90° con deflector

Té 90° avec déflecteur

Raccordo a T 90° con deflettore interno

DWKL317F

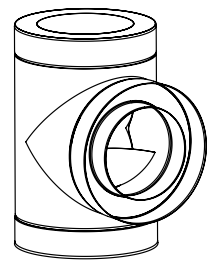
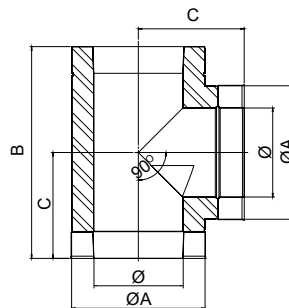

Ø	150	180	200	250	300	350	400	450	500	550	600	650	700	750	800
ØA	250	280	300	350	400	450	500	550	600	650	700	750	800	850	900
B	426	456	476	526	576	626	676	726	776	826	876	926	976	1026	1076
C	213	203	238	263	288	313	338	363	388	413	438	463	488	513	538

Tee 135°

Te 135°

Té 135°

Raccordo a T 135°

DWKL12

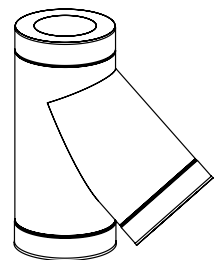
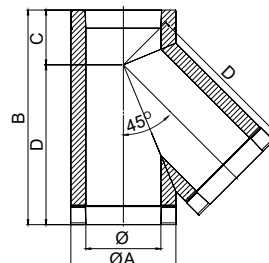

Ø	150	180	200	250	300	350	400	450	500	550	600	650	700	750	800
ØA	250	280	300	350	400	450	500	550	600	650	700	750	800	850	900
B	574	616	644	715	786	856	927	998	1069	1139	1231	1281	1351	1422	1493
C	162	168	172	182	193	203	213	224	234	244	258	265	279	286	296
D	412	448	472	532	533	593	653	714	774	834	895	1015	1076	1136	1196

Elbow 90° with flanged inspection

Codo 90° con inspección embridada

Coude 90° avec trappe de visite

Curva 90° con tappo d'ispezione flangiato

DWKL19HT

Ø	150	180	200	250	300	350
ØA	250	280	300	350	400	450
B	233	248	258	283	308	333
ØC	130			150	200	
ØH	180			200	250	

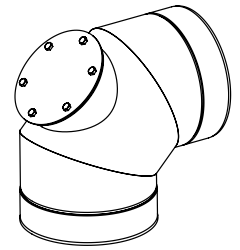
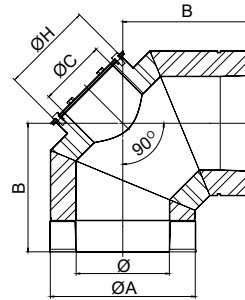

Inspection length with flanged door

Módulo de inspección embridado

Élément d'inspection 500Pa (H1)

Elemento ispezione con flangia

DWKL10HT

Ø	150	180	200	250	300	350	400	450	500	550	600	650	700	750	800
ØA	250	280	300	350	400	450	500	550	600	650	700	750	800	850	900
B	400		430			500									
ØC	150		180			250									
ØH	200		230			300									

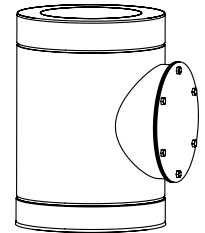
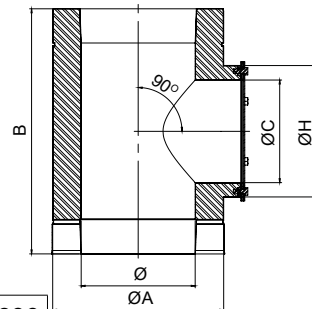

NFX Inspection length

Módulo de inspección NFX

Élément avec trappe de visite NFX

Elemento d'ispezione NFX

DWKL2034

Ø	250	300	350	400	450	500	550	600	650	700	750	800
ØA	350	400	450	500	550	600	650	700	750	800	850	900
N*	1			2								

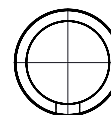
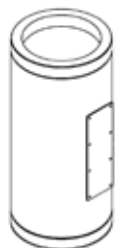
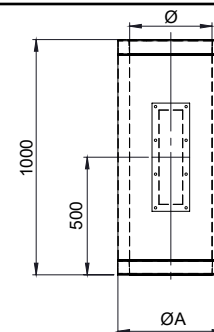

*Hace referencia al nº de puertas según el Ø / number of noozels by diameter

Inspection lenght with door 200Pa (P1)

Modulo de inspeccion con tapa 200Pa (P1)

Élément d'inspection 200Pa (P1)

Elemento ispezione con tappo 200Pa (P1)

DWKL549

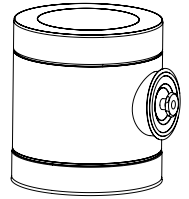
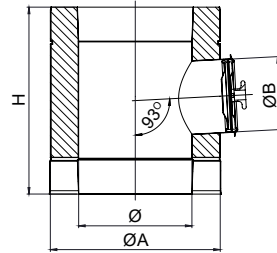

Ø	150	180	200	250	300	350	400	450	500	550	600	650	700	750	800
ØA	250	280	300	350	400	450	500	550	600	650	700	750	800	850	900
ØB	130						200								
H	330						500								

Tee cap insulated

Colector de hollín aislado

Tampon de bas de conduit isolé

Tappo coibentato

DWKL2033

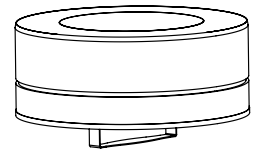
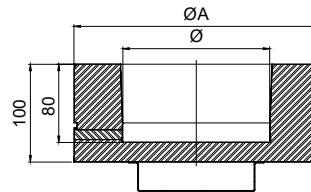

Ø	150	180	200	250	300	350	400	450	500	550	600	650	700	750	800
ØA	250	280	300	350	400	450	500	550	600	650	700	750	800	850	900

Tee cap with drain insulated

Colector de hollín con desagüe aislado

Tampon purge isolé

Tappo coibentato con scarico condensa

DWKL1460

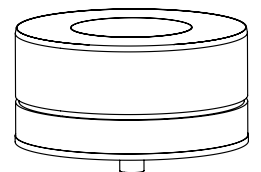
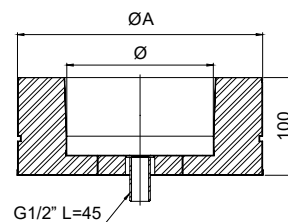

Ø	150	180	200	250	300	350	400	450	500	550	600	650	700	750	800
ØA	250	280	300	350	400	450	500	550	600	650	700	750	800	850	900

Tee cap with side drain

Colector de hollín con desagüe lateral

Tampon avec purge latérale

Tappo con scarico condensa laterale

DWKL1

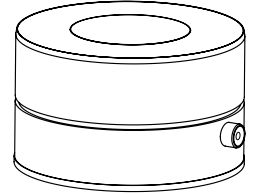
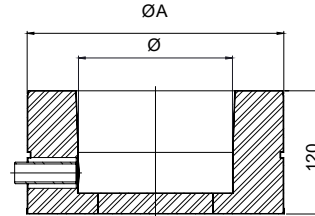

Ø	150	180	200	250	300	350	400	450	500	550	600	650	700	750	800
ØA	250	280	300	350	400	450	500	550	600	650	700	750	800	850	900

Hook and plate for inspection length

Gancho y pletina para módulo de inspección

Crochet et plaque pour élément d'inspection

Fascia di supporto per strumento di analisi.

DWKL4394

ABRAZADERA CON PLETINA

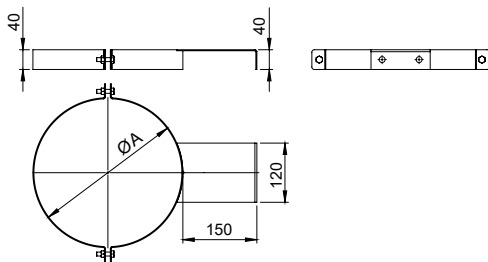

Ø 400 < (2 pletinas)

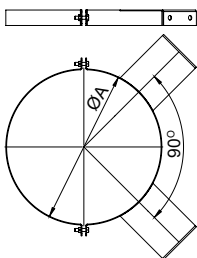

ABRAZADERA CON GANCHOS

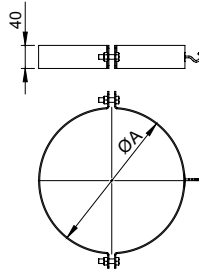

Ø 400 < (2 ganchos)

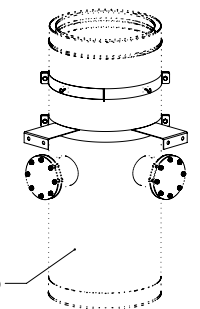
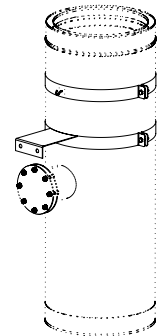
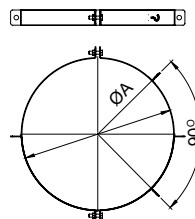

Módulo no incluido

Ø	150	180	200	250	300	350	400	450	500	550	600	650	700	750	800
ØA	250	280	300	350	400	450	500	550	600	650	700	750	800	850	900

Inspection element with nozzles

Módulo de medioambiente

Elément + prise test

Elemento ispezione con flangia

DWKL1268

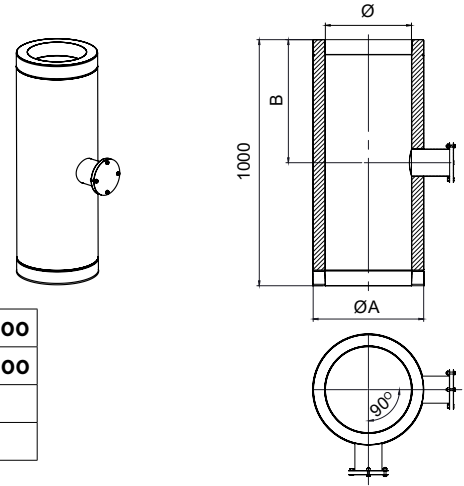

Ø	150	180	200	250	300	350	400	450	500	550	600	650	700	750	800	
ØA	250	280	300	350	400	450	500	550	600	650	700	750	800	850	900	
B	150				500											
N*	1				2x90°											

*Hace referencia al nº de puertas según el Ø / number of noozels by diameter

Topstub

Terminal salida libre

Finition haute

Terminale verticale

DWKL32

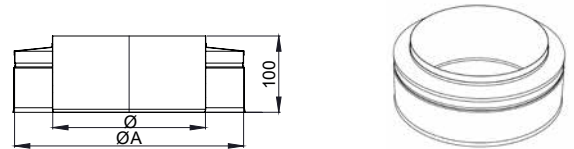

Ø	150	180	200	250	300	350	400	450	500	550	600	650	700	750	800
ØA	250	280	300	350	400	450	500	550	600	650	700	750	800	850	900

Conical topstub

Terminal salida cónica

Cône de finition standard

Terminale tronco-conico

DWKL32C

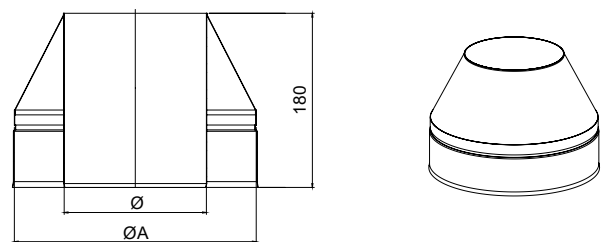

Ø	150	180	200	250	300	350	400	450	500	550	600	650	700	750	800
ØA	250	280	300	350	400	450	500	550	600	650	700	750	800	850	900

Rain cap

Terminal anti-lluvia

Terminal anti pluie

Terminale parapioggia

DWKL526

Ø	150	180	200	250	300	350	400
ØA	250	280	300	350	400	450	500
ØB	250	300	350	500	600	700	800
H	175	225		300			

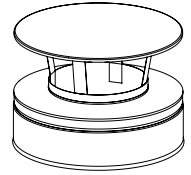
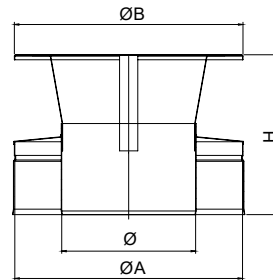

Horizontal terminal with mesh

Terminal horizontal con rejilla

Sortie sifflet avec grille

Terminale orizzontale con rete

DWKL532

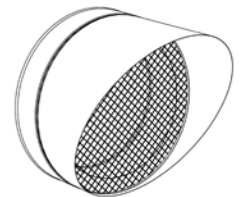
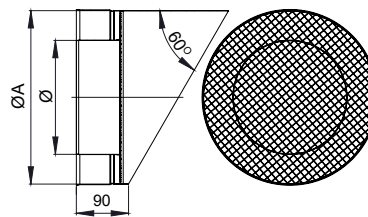

Ø	150	180	200	250	300	350	400	450	500	550	600	650	700	750	800
ØA	250	280	300	350	400	450	500	550	600	650	700	750	800	850	900

Topstub 600°C

Terminal cónico alta temperatura

Cône de finition HT (avec compensateur)

Terminale conico alta temperatura

DWKL32HT

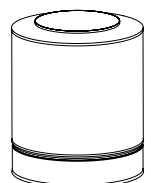
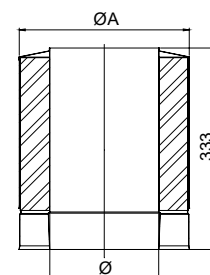

Ø	150	180	200	250	300	350	400	450	500	550	600	650	700	750	800
ØA	250	280	300	350	400	450	500	550	600	650	700	750	800	850	900

JET terminal (High Temperature)

Terminal JET (Alta temperatura)

Terminal JET (Haute temperature)

Terminale JET alta temperatura

DWKL34HT

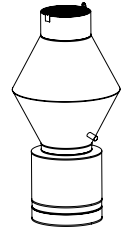
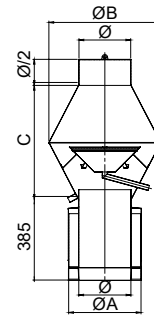

Ø	150	180	200	250	300	350	400	450	500	550	600	650	700	750	800
ØA	250	280	300	350	400	450	500	550	600	650	700	750	800	850	900
ØB	384	430	460	536	612	765	845	925	1010	1090	1200	1315	1400	1485	1600
C	450	480	500	550	600	650	700	750	800	850	950	950	1000	1050	1100

Adaptor for site welding (same diameter)

Adaptador para soldar (mismo diámetro)

Raccord à souder (même diamètre)

Adattatore per saldatura (stesso diametro)

DWKL2049

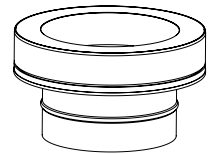
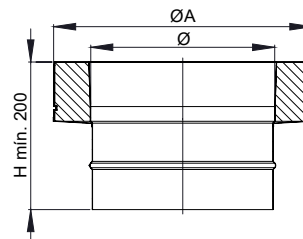

Ø	150	180	200	250	300	350	400	450	500	550	600	650	700	750	800
ØA	250	280	300	350	400	450	500	550	600	650	700	750	800	850	900

Boiler adaptor female (same diameter)

Adaptador caldera hembra (mismo diámetro)

Raccord chaudière femelle (même diamètre)

Raccordo femina (stesso diametro)

DWKL37H

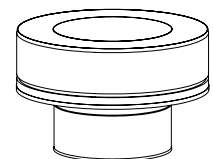
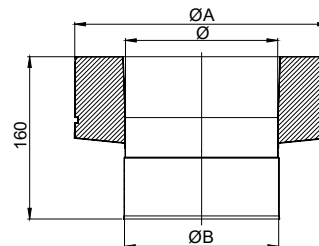

Ø	150	180	200	250	300	350	400	450	500	550	600	650	700	750	800
ØA	250	280	300	350	400	450	500	550	600	650	700	750	800	850	900
ØB	153	183	203	253	303	353	403	453	503	553	603	653	703	753	803

Boiler adaptor male (same diameter)

Adaptador caldera macho (mismo diámetro)

Raccord chaudière mâle (même diamètre)

Raccordo maschio (stesso diametro)

DWKL37M

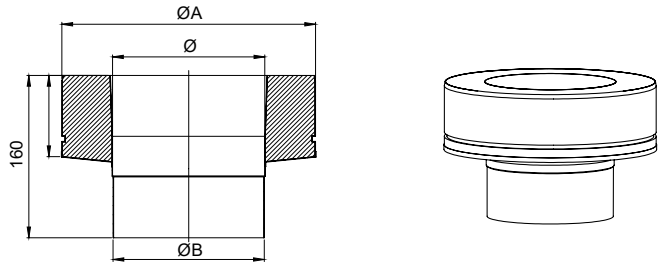

Ø	150	180	200	250	300	350	400	450	500	550	600	650	700	750	800
ØA	250	280	300	350	400	450	500	550	600	650	700	750	800	850	900
ØB	147	177	197	247	297	347	397	447	497	547	597	647	697	747	797

Single wall-twin wall adaptor

Adaptador simple a doble

Raccord simple à double

Raccordo mono-doppia parete

DWKL37

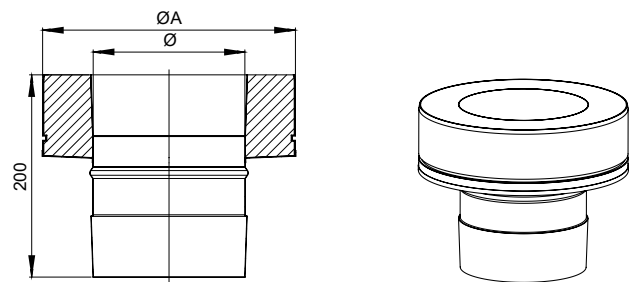

Ø	150	180	200	250	300	350	400	450	500	550	600	650	700	750	800
ØA	250	280	300	350	400	450	500	550	600	650	700	750	800	850	900

Twin wall-single wall adaptor

Adaptador doble a simple

Raccord double à simple

Raccordo doppia-mono parete

DWKL37A

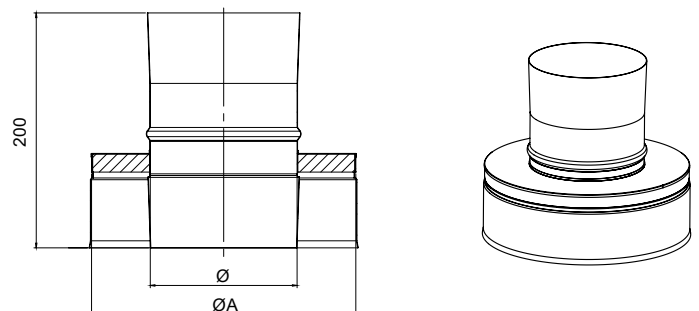

Ø	150	180	200	250	300	350	400	450	500	550	600	650	700	750	800
ØA	250	280	300	350	400	450	500	550	600	650	700	750	800	850	900

Flange adaptor way out

Adaptador embridado de salida

Raccord bridé sortie

Raccordo flangia uscita

DWKL856

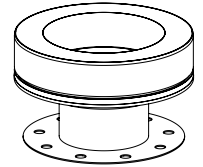
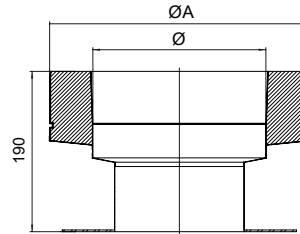

Ø	150	180	200	250	300	350	400	450	500	550	600	650	700	750	800
ØA	250	280	300	350	400	450	500	550	600	650	700	750	800	850	900

Flanged adaptor way in

Adaptador embridado entrada

Raccord bridé entrée

Raccordo flangia entrata

DWKL971

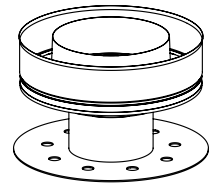
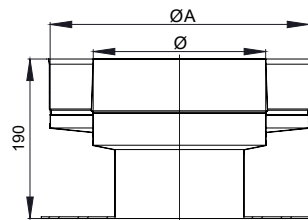

Ø	150	180	200	250	300	350	400	450	500	550	600	650	700	750	800
ØA	250	280	300	350	400	450	500	550	600	650	700	750	800	850	900

Decreaser (1 diameter)

Reducción (1 diámetro)

Réduction (1 diamètre)

Riduzione conica (1 diametro)

DWKL982

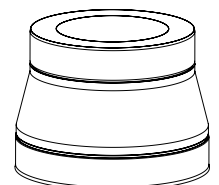
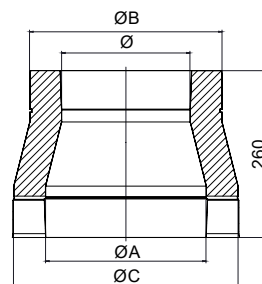

Ø	150	180	200	250	300	350	400	450	500	550	600	650	700	750	800
ØA	180	200	250	300	350	400	450	500	550	600	650	700	750	800	850
ØB	250	280	300	350	400	450	500	550	600	650	700	750	800	850	900
ØC	280	300	350	400	450	500	550	600	650	700	750	800	850	900	950

Increaser (1 diameter)

Ampliación cónica (1 diámetro)

Augmentation (1 diamètre)

Aumento (1 diametro)

DWKL983

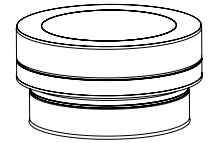
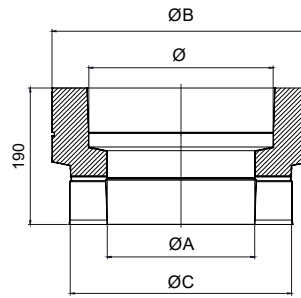

Ø	150	180	200	250	300	350	400	450	500	550	600	650	700	750	800
ØA	130	150	180	200	250	300	350	400	450	500	550	600	650	700	750
ØB	250	280	300	350	400	450	500	550	600	650	700	750	800	850	900
ØC	230	250	280	300	350	400	450	500	550	600	650	700	750	800	850

Adjustable wall support L=220 mm

Soporte de carga regulable L= 220 mm

Support mural ajustable L=220 mm

Piastra intermedia supporto a muro L=220 mm

DWKL379

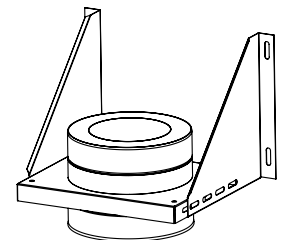
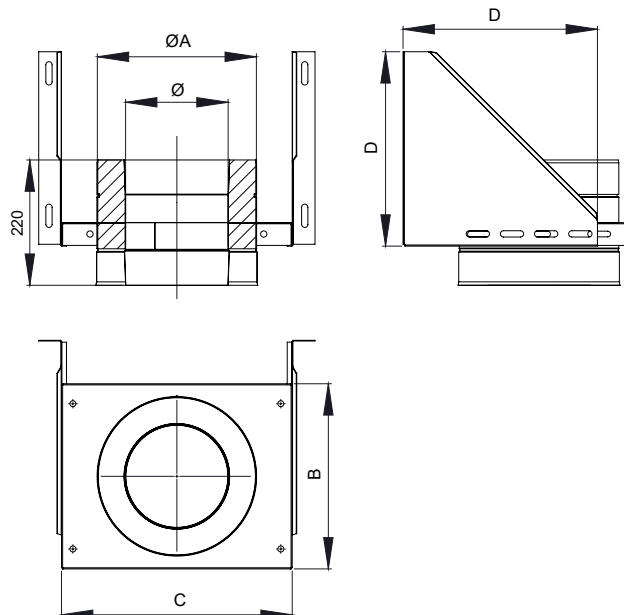

Ø	150	180	200	250	300	350	400	450	500	550	600	650	700	750	800
ØA	250	280	300	350	400	450	500	550	600	650	700	750	800	850	900
B	295	325	345	395	445	495	545	595	645	695	745	795	845	895	945
C	375	405	425	475	525	575	625	675	725	775	825	875	925	975	1025
D	310	340	360	410	460	510	560	610	660	710	760	810	860	910	960

Intermediate wall support plate

Placa de soporte de carga regulable

Plaque support réglable

Piastra intermedia senza angolari

DWKL7

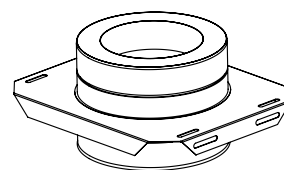
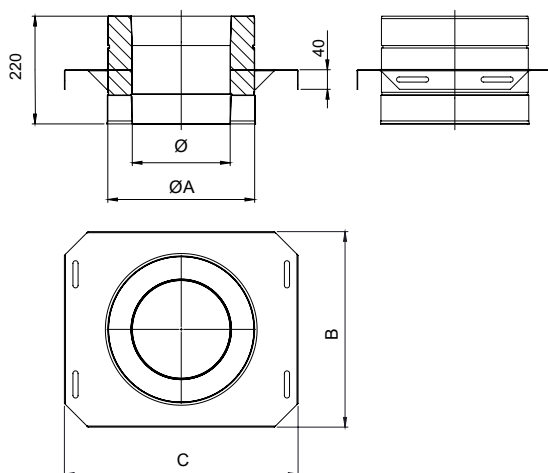

Ø	150	180	200	250	300	350	400	450	500	550	600	650	700	750	800
ØA	250	280	300	350	400	450	500	550	600	650	700	750	800	850	900
B	295	325	345	395	445	495	545	595	645	695	745	795	845	895	945
C	375	405	425	475	525	575	625	675	725	775	825	875	925	975	1025

Cantilever L=500 mm

Soporte distanciador L= 500 mm

Rallonges de support L=500 mm

Mensola di sostegno L=500 mm

DWKL392

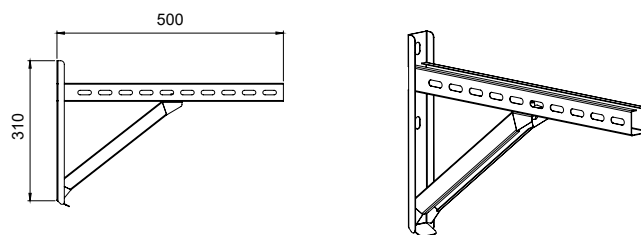

Mast support

Soporte de mástil

Support de mât

Piastra tampone

DWKL1295

\varnothing	150	180	200	250	300	350	400	450	500	550	600	650	700	750	800
$\varnothing A$	250	280	300	350	400	450	500	550	600	650	700	750	800	850	900
$\varnothing B$	350	380	400	450	500	550	600	650	700	750	800	850	900	950	1000
$\varnothing C$	310	340	360	410	460	510	560	610	660	710	760	810	860	910	960
n° agujeros / bore	8	10		12			14				16				

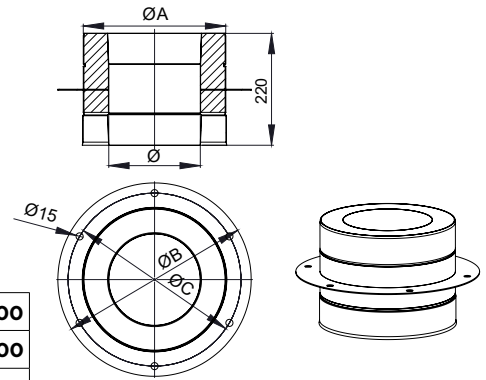

Horizontal end plate

Placa tope horizontal

Point fixe horizontal

Piastra tampone orizzontale

DWKL1465

\varnothing	150	180	200	250	300	350	400	450	500	550	600	650	700	750	800
$\varnothing A$	250	280	300	350	400	450	500	550	600	650	700	750	800	850	900
$\varnothing B$	265	295	315	365	415	465	515	565	615	665	715	765	815	865	915

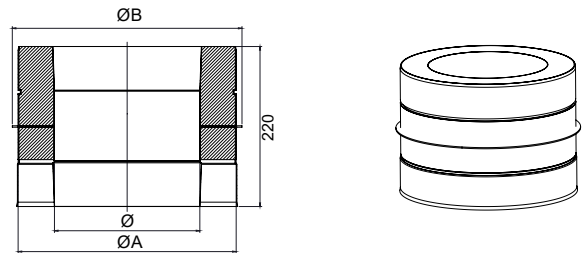

Adjustable base support 60-1115mm

Soporte base regulable 60-1115 mm

Support autoportant écoulement régl. 60-1115mm

Piastra di base regolabile 60-1115mm

DWKL4

\varnothing	150	180	200	250	300	350	400	450	500	550	600	650	700	750	800
$\varnothing A$	250	280	300	350	400	450	500	550	600	650	700	750	800	850	900

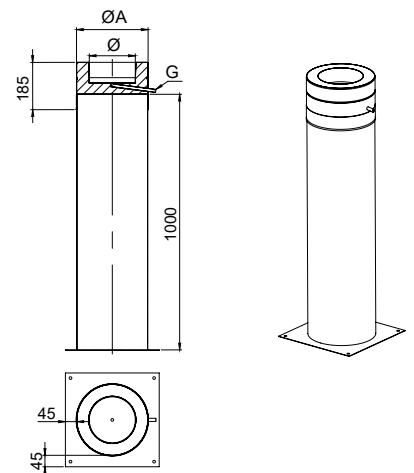

Locking band 2.0

Abrazadera de unión 2.0

Bride de sécurité 2.0

Fascetta di chiusura 2.0

DW50989

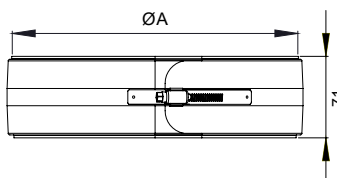

Ø	150	180	200	250	300	350	400	450	500	550	600	650	700	750	800
ØA	250	280	300	350	400	450	500	550	600	650	700	750	800	850	900

Split ring

Abrazadera para amarre por tornillo

Collier de suspension

Fascetta di anello

DW501063

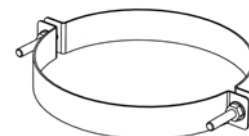
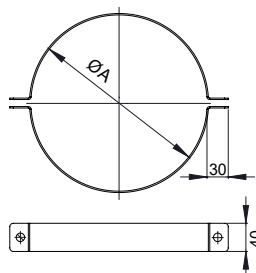

Ø	150	180	200	250	300	350	400	450	500	550	600	650	700	750	800
ØA	250	280	300	350	400	450	500	550	600	650	700	750	800	850	900

Adjustable wall bracket 50-80 mm

Abrazadera de fijación pared regulable 50-80 mm

Collier mural réglable 50-80 mm

Fascetta a parete regolabile 50-80 mm

DW50556

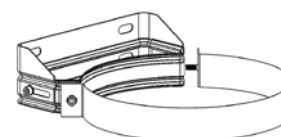
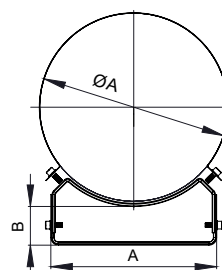
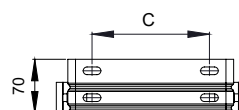

Ø	150	180	200	250	300	350
ØA	250	280	300	350	400	450
A	217	252	252	287	346	358
B	50-80					
C	150	185	185	220	280	292

Fixed wall bracket

Abrazadera fijación pared fija

Collier mural fixe

Fascetta a parete fissa

DW50556F

Ø	400	450	500	550	600	650	700	750	800	
ØA	500	550	600	650	700	750	800	850	900	
A	444		500		550		650	750		
B	344		400		450		550	560	650	
C	122						162	192		
D	61	71	54	63	50	58	58	60		

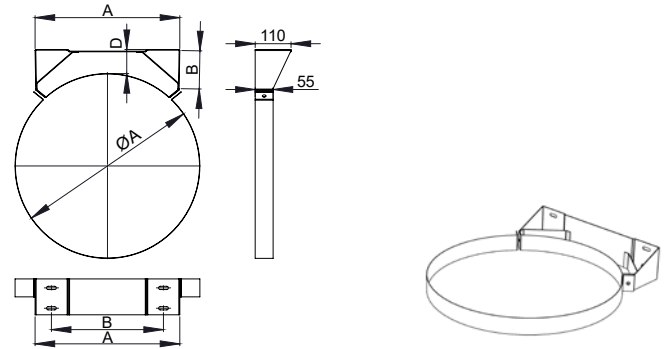

Wall support bracket

Abrazadera de soporte

Collier de support

Fascetta soporte a parete

DW50858

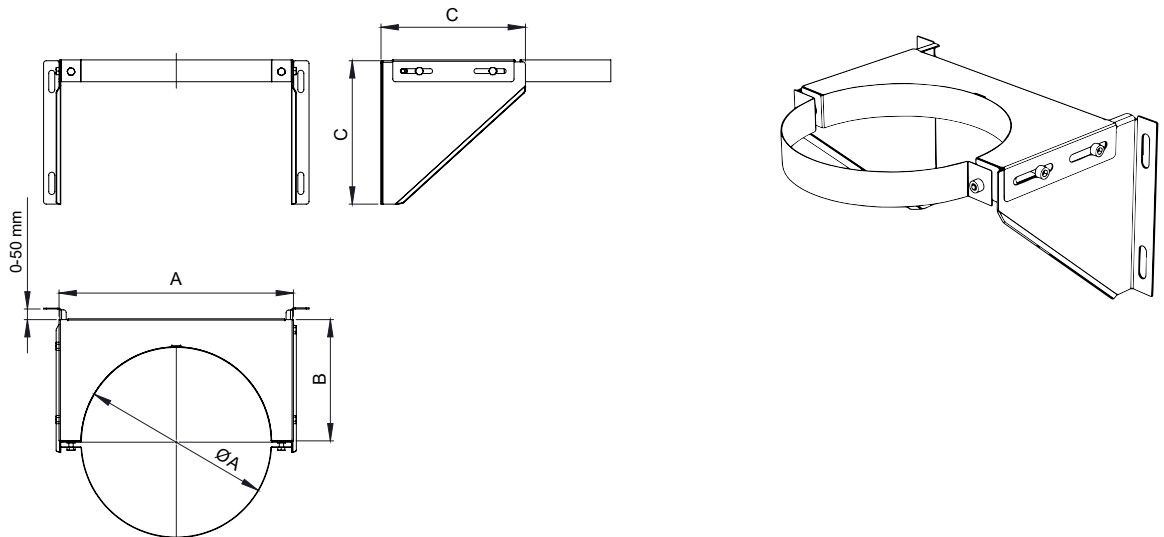

Ø	150	180	200	250	300	350	400	450	500	550	600	650	700	750	800
ØA	250	280	300	350	400	450	500	550	600	650	700	750	800	850	900
A	330	360	380	430	480	530	580	630	680	730	780	830	880	930	980
B	175	190	200	225	250	275	300	325	350	375	400	425	450	475	500
C	215	230	240	265	290	315	340	365	390	415	440	465	490	515	540

Wall distance bracket base

Base de abrazadera distanciadora

Collier mural pour rallonges

Base di fascetta regolabile

DW501462

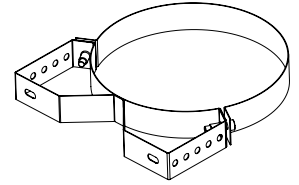
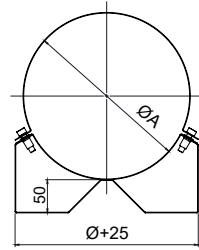
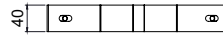

Ø	150	180	200	250	300	350	400	450	500	550	600	650	700	750	800
ØA	250	280	300	350	400	450	500	550	600	650	700	750	800	850	900

Wall distance rails

Alas distanciadoras

Rallonges réglables

Prolunghe

ZUWA1462A

ZUWA1462B

ZUWA1462C

ZUWA1462D

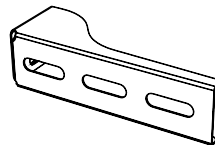

ZUWA1462A

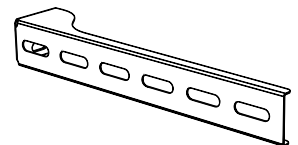

ZUWA1462B

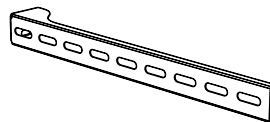

ZUWA1462C

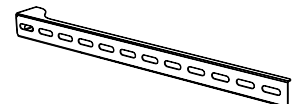

ZUWA1462D

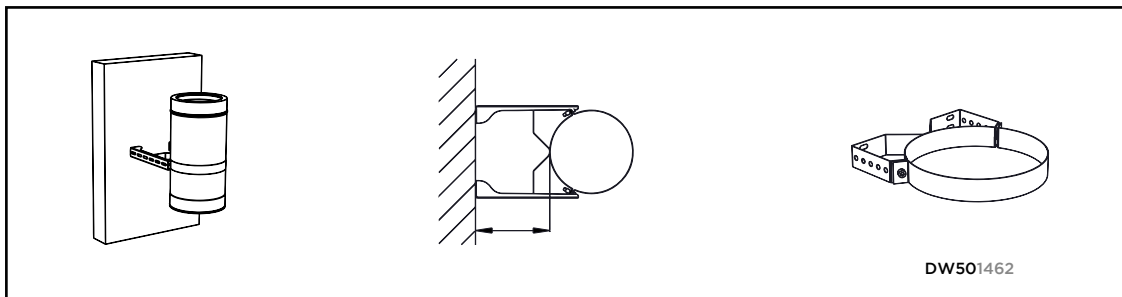

Note: These brackets are not designed to bear the total weight of the chimney, but to bear the lateral loads.

Nota: Estas abrazaderas no están diseñadas para soportar el peso de la chimenea, sino sólo para soportar las cargas laterales.

Note: Toutes ces brides ne sont pas conçues pour soutenir le poids de la cheminée tandis que seulement pour soutenir les charges latérales.

Nota: queste flange non sono progettate per supportare il peso del camino, ma solo per supportare carichi laterali.

Ø	150	180	200	250	300	350	400	450	500	550	600	650	700	750	800
1462A	100	80	80	65	50	-	-	-	-	-	-	-	-	-	-
1462B	250	230	230	215	200	175	150	135	110	85	65	-	-	-	-
1462C	400	380	380	365	365	325	300	285	260	235	215	190	170	150	125
1462D	550	530	530	515	500	475	450	435	410	385	365	340	320	300	275

Level bracket

Abrazadera forjado inox

Collier mural simple

Fascetta a piano

DW5062

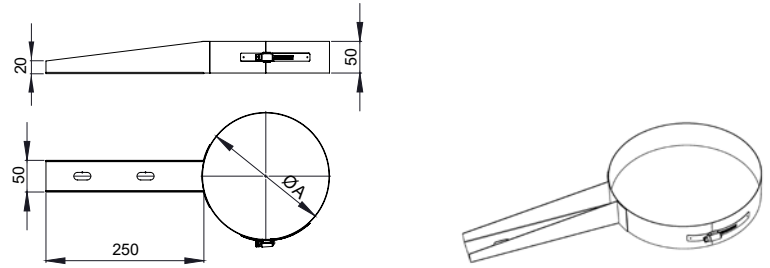

Ø	150	180	200	250	300
ØA	250	280	300	350	400

Roof support

Soporte de techo

Support au toit

Supporto a tetto

DW50936

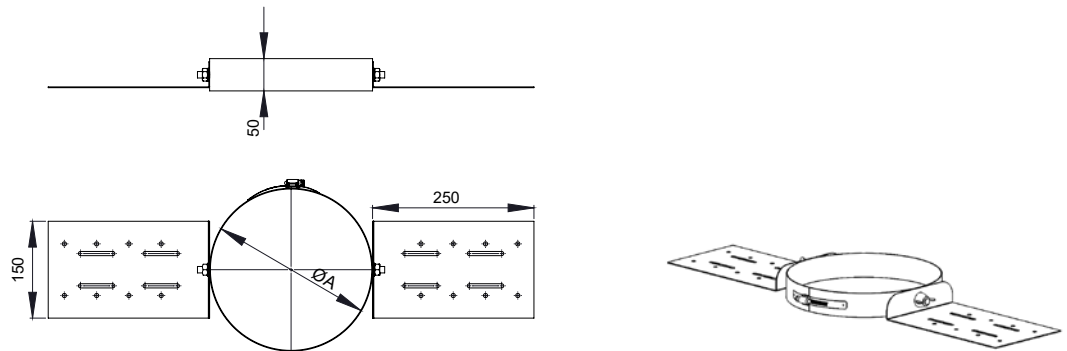

Ø	150	180	200	250	300	350	400	450	500	550	600	650	700	750	800
ØA	250	280	300	350	400	450	500	550	600	650	700	750	800	850	900

Guy wire bracket

Abrazadera vientos

Collier de haubanage

Fascetta per cavi tiranti

DW5042

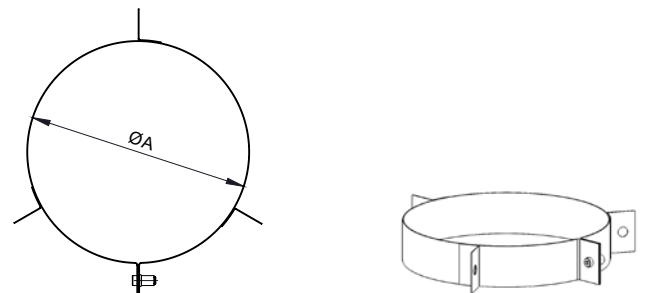

Ø	150	180	200	250	300	350	400	450	500	550	600	650	700	750	800
ØA	250	280	300	350	400	450	500	550	600	650	700	750	800	850	900

Roof stabiliser bracket

Abrazadera con doble pértiga telescópica

Haubans rigides avec bride

Fascetta stabilizzante sopra tetto

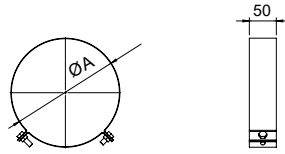

DW50191

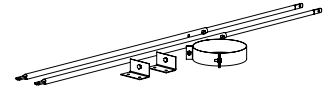
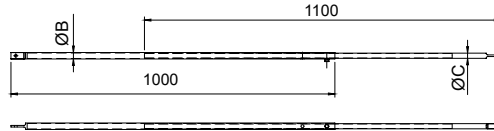

Ø	150	200	250	300	350	400	450	500	550	600	650	700	750	800
ØA	250	300	350	400	450	500	550	600	650	700	750	800	850	900
ØB	20				30									
ØC	16				25									

Wall sleeve

Pasamuros

Traversée murale

Pasaggio a muro

DW50987

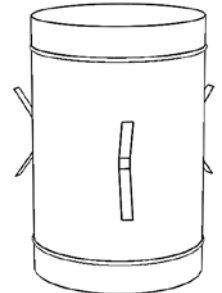
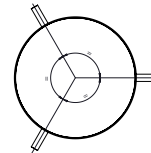
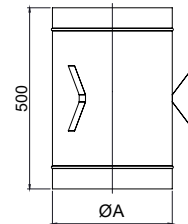

Ø	150	200	250	300	350	400	450	500	550	600	650	700	750	800
ØA	280	330	380	430	480	530	580	630	680	730	780	830	880	930

Stainless Steel flat flashing

Cubreaguas plano inox

Solin plat inox

Faldale piatto in inox

DW501128

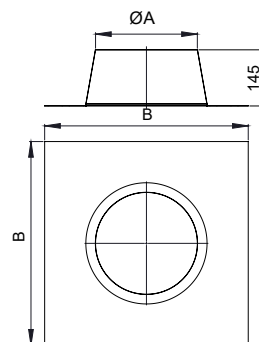

Ø	150	180	200	250	300	350	400	450	500	550	600	650	700	750	800
A Ø	280	310	330	380	430	480	535	585	635	685	735	785	835	885	935
B	540	570	590	640	690	740	795	845	895	945	1000	1050	1100	1150	1200

Flashing lead base 0° - 5°

Cubreaguas plomo 0° - 5°

Solin 0° - 5° plomb

Faldale con base in piombo 0° - 5°

DW50937

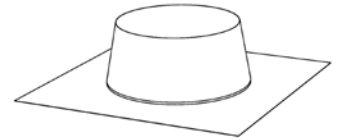
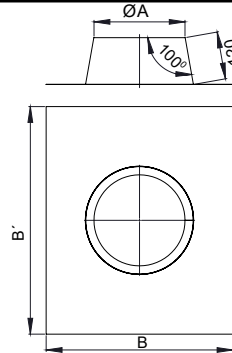

Ø	150	180	200	250	300	350	400	450	500	550	600	650	700	750	800
A Ø	280	310	330	380	430	480	535	585	635	685	735	785	835	885	935
B	750				1000							1050	1100	1150	1150
B'	1000										1050	1100	1150	1150	

Flashing lead base 5° - 25°

Cubreaguas plomo 5° - 25°

Solin 5° - 25° plomb

Faldale con base in piombo 5° - 25°

DW50938

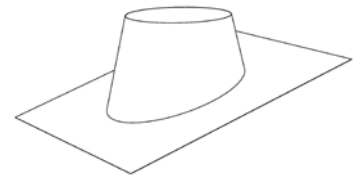
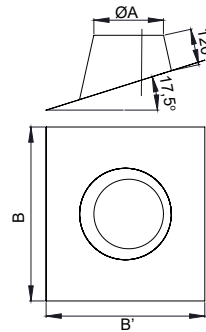

Ø	150	180	200	250	300	350	400	450	500	550	600	650	700	750	800
A Ø	280	310	330	380	430	480	535	585	635	685	735	785	835	885	935
B	750				1000	1100	1200	1300	1400	1500					
B'	1000				1200	1200	1300	1400	1400	1500					

Flashing lead base 25° - 45°

Cubreaguas plomo 25° - 45°

Solin 25° - 45° plomb

Faldale con base in piombo 25° - 45°

DW50939

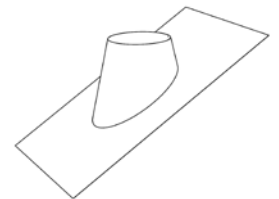
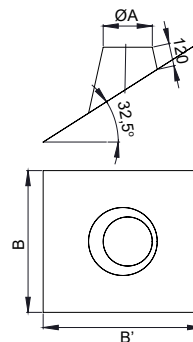

Ø	150	180	200	250	300	350	400	450	500	550	600	650	700	750	800
A Ø	280	310	330	380	430	480	535	585	635	685	735	785	835	885	935
B	750				1000	1100	1200	1300	1400	1500					
B'	1000				1200	1200	1300	1400	1400	1500					

Flashing 5°-25° (Alu based)

Cubreaguas 5°-25° aluminio

Solin 5°-25° aluminium

Faldale con base in alluminio 5°-25°

DW50938AL

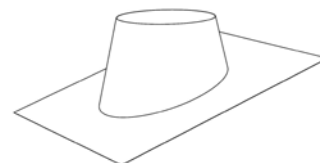
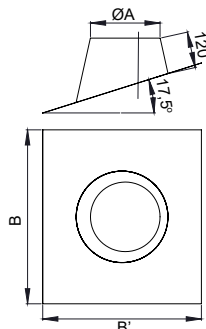

Ø	150	180	200	250	300	350	400	450	500	550	600	650	700	750	800
A Ø	280	310	330	380	430	480	535	585	635	685	735	785	835	885	935
B	750				1000						1100	1200	1250	1300	1300
B'	1000				1200	1200	1300	1400	1400	1500					

Flashing 25°-45° (Alu based)

Cubreaguas 25°-45° aluminio

Solin 25°-45° aluminium

Faldale con base in alluminio 25°-45°

DW50939AL

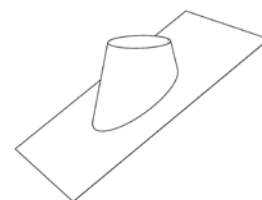
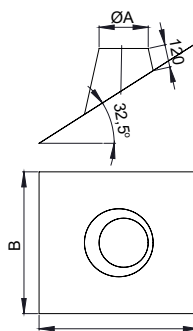

Ø	150	180	200	250	300	350	400	450	500	550	600	650	700	750	800
A Ø	280	310	330	380	430	480	535	585	635	685	735	785	835	885	935
B	750				1000	1100	1200	1300	1300	1500					
B'	1000				1200	1200	1300	1400	1400	1500					

Storm collar / Embellisher

Collarín antitormenta

Collerette de solin

Fascia parapigioggia

DW50307

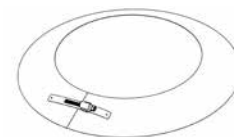
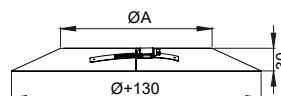

Ø	150	200	250	300	350	400	450	500	550	600	650	700	750	800
ØA	280	330	380	430	480	530	580	630	680	730	780	830	880	930

Storm collar / Embellisher

Collarín antitormenta

Collerette de solin

Fascia parapioggia

DW50307L

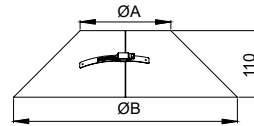

ØA	150	180	200	250	300	350	400	450	500	550	600	650	700	750	800
ØB	470	500	520	570	620	670	720	770	820	870	920	970	1020	1070	1120



www.jeremias.uk

www.jeremias.es

www.jeremias-france.fr

www.jeremias.it

www.jeremias-group.com